

Zubehörkanal

Zubehörkanäle

Code: 3026 880



EINZELHEITEN

Einbaurand	Unterbau
Material	Edelstahl AISI 304
Finish	Spazzolato Foster
Textur	Bürstung in Linie
Basis	120 cm
Außenmaße	1138 x 170 mm
Innenmaße	1122 x 122 mm
	113,8 cm
Länge	8 einheit - Standard

Einbauöffnung

Siehe Datenblatt (für alle FT/FTS- und Unterbau-Modelle)

Serienmäßige Ausstattung

Befestigungshaken, Abfluss, im Karton verpackt

Abfluss

Abfluss 1 $\frac{1}{4}$ "

Schlüssel für das Zubehör

Die Längen der Kanäle und des Zubehörs werden in „Einheiten“ angegeben, für die Zusammensetzung muss die Summe der "Einheiten" des Zubehörs der Länge in "Einheiten" des Kanals entsprechen.

TECHNISCHE DATEN

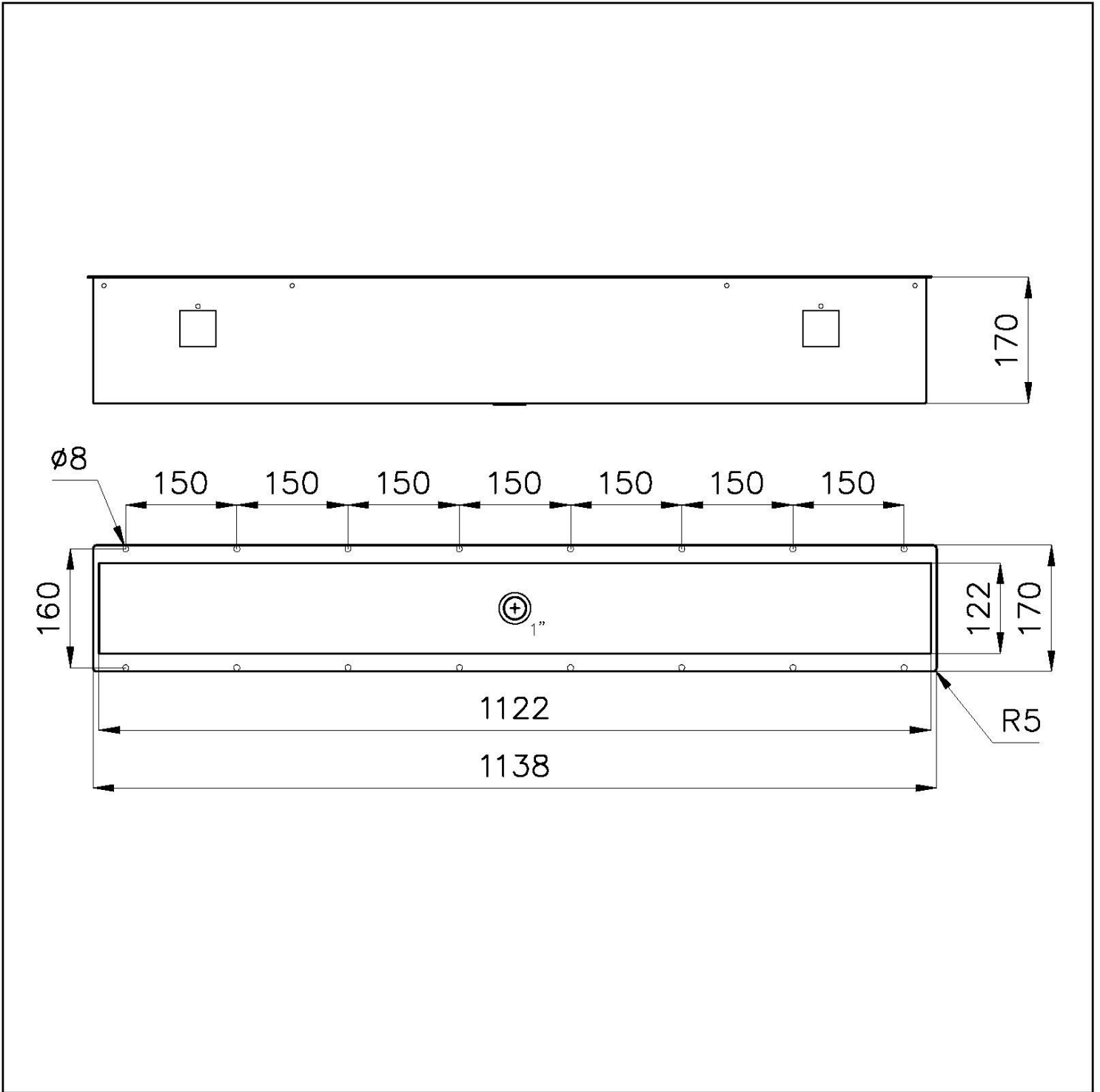

Sottotop/Undermount

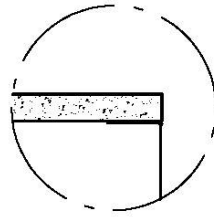

B-B:
Dettaglio installazione
Installation detail

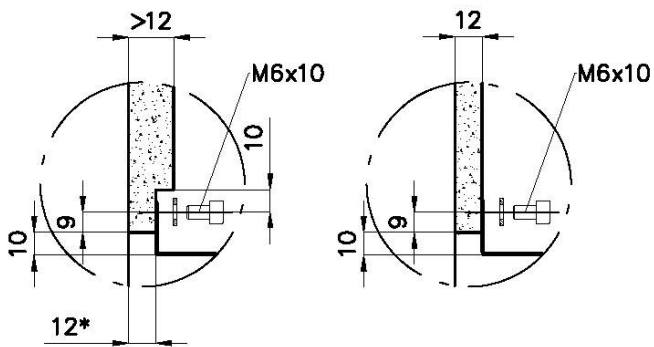

A-A:
Dettaglio installazione positive reveal e sistema di fissaggio
Installation detail with positive reveal and fixing system

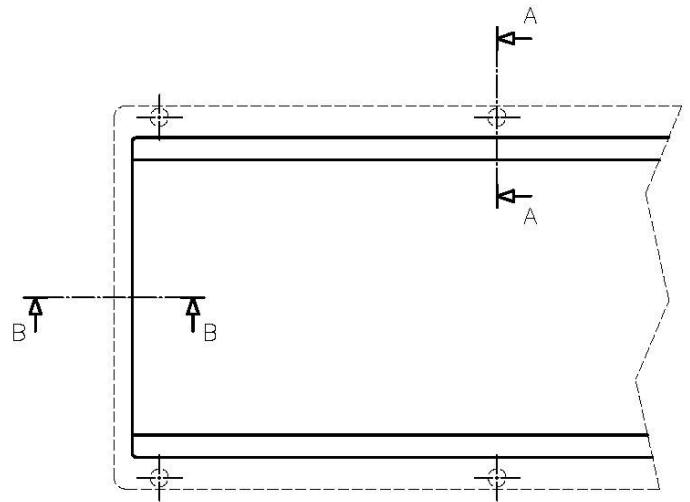

*spessore consigliato per un abbinamento perfetto con gli accessori
*recommended thickness for a perfect match with the accessories

Dimensioni per foratura top
Cut out size

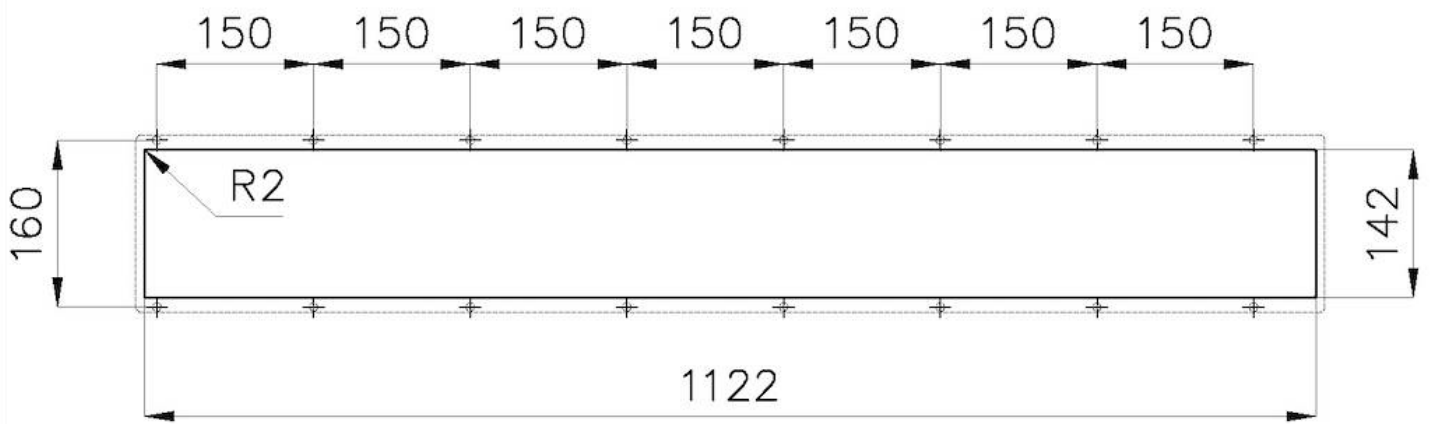

GALERIE



OPTIONALES ZUBEHÖR



Kit "A"
8100 703



Kit "B"
8100 700



Kit "C"
8100 701



Kit "D"
8100 704



Kit "E"
8100 705



Kit "F"
8100 706



Kit "G"
8100 710



Kit "H"
8100 702



Kit "N"
8100 714



Perforierte Edelstahlwanne
8151 003



Stainless steel knife holder
8100 712



Steckdosenleiste aus Edelstahl
8000 020



Tellerständer aus Edelstahl
1773 100